



CHAM

PHOENICS- your gateway to Successful CFD

**P
H
O
E
N
I
C
S

N
E
W
S**

Winter 2012/13

Editorial

Professor Spalding was born on January 9 1923 in New Malden England. He went to school locally and, as he tells it, conformed to what was required of a schoolboy of the day. However he started to carve out an independent path when he chose to read Engineering at Oxford rather than the more accepted Classics or Arts.

He got a BA(Hons) in Engineering Science in 1944, his MA from Oxford in 1948, his PhD from Cambridge in 1952 and an ScD from Cambridge in 1966. The subject of his PhD was the "Combustion of Liquid Fuels". Whilst working on this he concluded that one had to consider the interactions of different and varied aspects of flow processes and chemical kinetics to understand phenomena such as combustion. He predicted that a critical rate of mass transfer was necessary to influence the effect chemical-reaction-rate constants had on combustion - a non-conformist prediction that was proved correct by subsequent experimentation.

He was working as a Demonstrator at Cambridge when he was head hunted to Join Imperial College in 1954 as Reader in Heat Transfer.

He spent most of the rest of his Academic career at Imperial becoming Professor of Heat Transfer and Head of the Heat Transfer Section in 1958.

He continued to introduce new ideas into his science including deriving a single formula for the law of the wall, working on unifying the theories of heat and mass transfer and, in the 1970s, foreseeing the place that computers would play in science.

This may seem obvious now but it was not ever thus; in the 70s the idea that computers would supplant the slide rule was perhaps considered somewhat avant garde by some of Spalding's colleagues as was his adoption of the concept of a finite volume method of mathematical development.

The 1970s were a busy period for Spalding and his students and research colleagues involving continued work on boundary layer theory, the production of GENMIX, a widely used and freely available computer code; development of the SIMPLE algorithm which, in the mid and late 70s was extended to multiphase flows via algorithms such as IPSA; the introduction of turbulence models, etc.

Brian, along with Francis Harlow, introduced Computational Fluid Dynamics (CFD) to the science community and he became Head of the Computational Fluid Dynamics Unit at Imperial in 1981, a position he held until his "retirement" in 1988.

Brian taught himself how to code whilst he was the Reilly Professor of Combustion at Purdue University in 1977/8 and wrote CHAMPION, closely followed by PHOENICS, the first commercial CFD code which is the basis for most of the codes which followed over the next 30 years.

Brian continues to work at CHAM which he founded in 1974. He still enjoys the process of having new ideas, still lectures and, perhaps more than anything, enjoys discussing scientific ideas with others who share his interests.

We at CHAM wish him a Happy 90th Year.

Colleen King
Editor

1) Brian through the Years



Kings College School, 1934



The Engineering Class of 1944 in 1994



1944



1960



Marrakesh Conference marking 85th Birthday 2007



1970

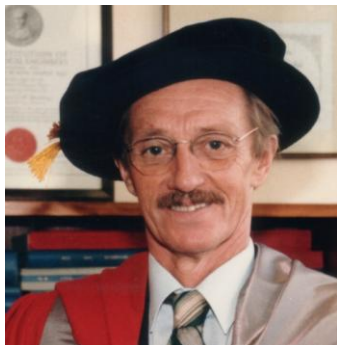

IC Staff Orator 1983



Global Energy Award 2009

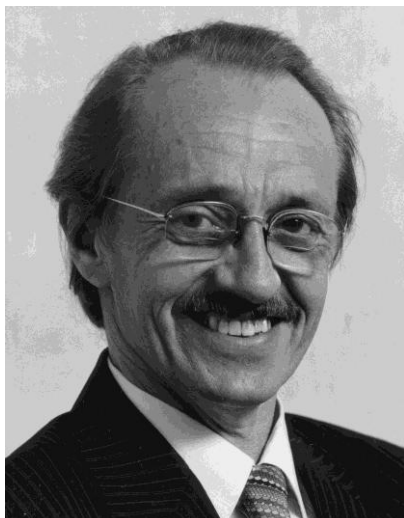

Fellow of the Royal Society 1983



Franklin Medal Award April 2011

2) Brian's 90th Year

2.1 Brian Spalding by Bob Hornby

I've had a long association with CHAM dating from 1980 when I joined the then National Nuclear Corporation (NNC). When I joined the Analysis Group there, early 2-D precursors to PHOENICS (VICSEN and 2EFIX as I recall) were being employed to help in the design of a Commercial Demonstration Fast Reactor (CDFR) using molten sodium as coolant. PHOENICS appeared soon after and was first applied to flow situations in the Advanced Gas Cooled Reactor (AGR, cooled by high pressure Carbon Dioxide gas), two of which were being built at Heysham and Torness. Later PHOENICS was also applied to the CDFR hot pool and steam generator design. PHOENICS allowed 3-D transient flows to be analysed and was particularly versatile in incorporating complicated source terms in the governing equations.

The main work that I was involved with on the AGR was reported at the CHAM User Conference in Nice in 1992. PHOENICS had been successfully applied (saving millions of pounds in reactor downtime) to the problems relating to the prediction of temperatures in damaged AGR fuel elements. The Conference was held at a holiday village just outside Nice. I remember superb food and unlimited (it seemed!) wine which set the scene for an excellent after dinner Conference speech by Brian. I recall that Brian included a particularly good joke which with the warm atmosphere, food and especially the wine had everyone in fits of laughter!

I joined the Defence Research Agency soon after (DRA, later to form part of the Defence Science and Technology Laboratory - DSTL) to work on ocean environments affecting the tracking of submarines. Soon I was applying PHOENICS to predicting the motion of large amplitude internal waves in the Ocean, work that was reported at another enjoyable PHOENICS User Conference in Luxembourg (except for my mistake in not removing my speaker's microphone before entering the toilet!).



I gave my final PHOENICS presentation on environmental work conducted at DSTL at Cannizaro House in London, prior to retiring in 2007. Again Brian was in attendance looking very much the same as in 1992! I'd love to know his secret....

Dr R. P. Hornby e-mail: bob@hornby007.wanadoo.co.uk

2.3 Professor Spalding at MEI (Moscow Engineering Institute) by Alexey Ginevsky

In Russia professor Spalding has been long known, probably for forty or fifty years, mostly among the scientific community engaged in computational fluid dynamics, heat transfer and combustion. His works are deservedly popular and several generations of researchers have grown up studying them.

Professor Spalding has lot of friends and followers among Russian scientists. He is often invited to take part in conferences in different cities of Russia. Almost always he accepts these invitations. Professor Spalding gave lectures in Moscow and St-Petersburg, Novosibirsk and Zvenigorod, and other cities of Russia.

But in our view, he has very specific relations with scientific community of the Moscow Engineering Institute. It is at this institute that the Moscow team of developers has been working under his guidance for the last 14 years and together with their colleagues from England continues development of PHOENICS modules.

A Few words of history

In late eighties first private companies started to appear in the Soviet Union after a long break. On this wave MEI graduate Sergey Zhubrin, after his training course in England, established a joint venture CHAM-MEI. The first aim of this organization was to promote PHOENICS in Russia. It is the appearance of this company which allowed MEI researchers to become closely acquainted with the world's first software package making possible simulation of numerous phenomena occurring in thermophysical systems. It should be noted that this acquaintance was rather efficient because the MEI scientific potential at that time was rather high, and if nobody was engaged in the development of general-purpose CFD codes, numerous MEI researchers of that time created their own computer calculation codes to solve their personal tasks. Therefore, the ideas embodied in PHOENICS were very close for many of us and more or less clear.

Political events of the early nineties, the collapse of the Soviet Union and subsequent sharp impoverishment of the population did not spare scientific staff. The number of people both working in science and engaged in science in high school decreased dramatically. CHAM-MEI was closed in the mid nineties and Sergey Zhubrin went to England. However, after a couple of years, on the initiative of Professor A. Dmitriev, a new company "Science – Service – Center" (SSC) based in MEI, signed an agreement with CHAM to promote PHOENICS in Russia. One item of the agreement was connected with conducting of joint research and development activities related to the development of PHOENICS in the "Science-Service-Center" Company under the leadership of Professor Spalding.

The first employee Professor Spalding involved in "SSC" was MEI graduate Nikolay Pavitsky who had worked with Sergey Zhubrin in CHAM-MEI and therefore was well known to Professor Spalding. After 2 or 3 years MEI

researchers Valery Artemov and Alexey Ginevsky joined Nikolay Pavitsky.

During this time our team made its own contribution to the development of PHOENICS: Inform and the Windows-version of the post-processor PHOTON were developed; operation of parallel PHOENICS in its present form was provided; MOFOR was implemented; the PARSOL code was updated; the PHOENICS ability of operating with unstructured grids was developed; a possibility of the joint solution of the problems of hydrodynamics, heat transfer and elasticity was updated, and a number of other developments were carried out. In our work we have been always guided by Professor Spalding's ideas and advice, and received any required assistance from both Professor Spalding and other CHAM developers in England.



From left to right: Valery Artemov, Brian Spalding, Alexey Ginevsky and Nikolay Pavitsky

Our communication

At the beginning of our joint work, despite the fact that Professor Spalding speaks Russian, there was concern as to whether we could understand each other well enough to make the exchange of ideas fruitful. After all, there were many obscure points that could affect communication invoking misunderstanding. However, at the first attempt to discuss a plan of work our worries vanished as if by magic. Already the first attempts of addressing "Professor, we..." were immediately suppressed. It was said simply: "You are Alexey and Valery, and I am Brian". This made an impression.

It soon became clear that we could ask Brian any question and he would try to answer it. The topics of our discussion were not always connected with purely scientific subjects but affected other aspects of life. It is interesting that our discussions are often conducted in a mixed Anglo-Russian dialect. Brian always tries to help our understanding of the matter and often uses Russian which he speaks well. However, when, in his opinion, it is necessary to formulate something with better accuracy, he turns to English. We try to do the same but it is not always possible to convey the thought in English quickly and correctly. It is therefore necessary to acknowledge that some communication problems do exist but they are very minor. At least when it comes to discussion of any direction of development, we keep discussing it until there is complete understanding of each other's point of view.



Scientific discussion

In our communication we do not for a moment forget that Professor Spalding is a world-renowned scientist whose scientific merits are unquestionable. It is therefore interesting to observe his methods of organizing work and developing individual components of the software we are working on. Purely scientific curiosity and related restlessness are inherent in Brian. Therefore, his development method is a 'step-by-step' one in which performance testing of each module under development and determination of its properties, advantages and drawbacks are carried out at each small step. Such a method, when one has to make frequent stops and create a special, at times very large, code to test a still unfinished project, is sometimes puzzling since it leads to long delays in the development course. But the analysis of the general situation makes it clear that this approach is almost always the most rational one.

A fact which induces surprise and admiration is that Brian manages a large number of directions simultaneously, on the one hand going into every detail of the product being developed and, on the other, leaving room for creativity of people working under his guidance. And not only leaving room for creativity, but very often encouraging it. He often dislikes when in our work we are guided by known methods. He often repeats that it is "necessary to find own ways, develop own original methods and ideas" in the chosen direction. At the same time, as a true scientist Brian experiences distrust to the results of others and sometimes puzzles us by a question: "And where it is known from? Who has tested this?" If there is no adequate answer, one can be sure that it will be difficult to convince him of the reliability of the information provided.

It is very interesting to listen to him. His public appearances at conferences are of particular interest. Each performance is an event because Brian is never stingy with new ideas, is always glad to share his ideas and arguments with others. In the last years to facilitate understanding he provides translation of his lectures into the national language of the country he is lecturing in (into Russian – in Russia, into Chinese – in China). So after his lecture there is a feeling that in an already familiar area you have considered something new, something that you ignored earlier. His lectures are therefore essential to young researchers. Usually a considerable part of his lecture Brian dedicates to them attempting to create a genuine interest in the subject of discussion, arising a feeling of their touching the wisdom and vast expanses of unexplored. In

his lectures Brian discloses a large number of new, not yet developed ideas in hope that a new generation of researchers will take part in their development.



Presentation at the conference "Heat transfer in swirling flows". Moscow, MEI, 2008.

We are grateful that fate has allowed us to communicate with such a unique person as Brian Spalding. As he reaches his ninetieth year, we wish him good health, long life and success in his work. **Moscow R&D team**

2.3 Brian Spalding by Nikolai Pavitsky



I owe a lot to this talented scientist. He was, and is, my Teacher. It so happened that his work has identified the flow of the life of my humble person. I first heard his name when I was a student. Already then the program PHOENICS was known in Russia. Its capabilities have been fantastic. Namely work with the package of these programs (Genmix, Champion) determined my future profession.

I remember the first meeting with the Professor, his lively interest in scientific problems and finding genius simple solutions. His favorite phrase is 'step by step'; it is a simple rule and is now helping me.

I also remember that the Professor's favorite example was case 249. He checked on it all the new features In-Form. Of course many things have changed since then. New library examples and new features of the program PHOENICS appeared. For example PHOENICS Direct. It is the new style of work with the CFD program.

I believe that Brian Spalding is the trendsetter in CFD simulations. First, his ideas appear in PHOENICS, and then in other CFD programs.

Nikolai Pavitsky, MEI, Moscow

2.3 Association with Professor Spalding, CHAM & PHOENICS by Eric Jal

I joined CHAM as my first job straight from university in late 1983 as part of the Consultancy team, then under Norman Rhodes. Being initially located in the "loft" of Bakery House, my early recollections of seeing Professor Spalding for the first time were when I would come into the office in the morning often quite early (pre 8AM) and see him in the adjacent office occupied by Harvey Rosten who along with Professor Spalding were the main developers of the "pioneering" general-purpose CFD code referenced as PHOENICS-81. I would often leave the office after 7PM and still see them there busily going over new developments and features that they would be introducing into PHOENICS. I suspect not much will have changed and no doubt Professor Spalding is still one of the first to arrive and last to leave the office to this day!!

Later on in my career, particularly when I (and others) would be struggling with a rather knotty technical problem over which we would be banging our heads against the wall (quite literally and no doubt some scars on the office walls still remain!?), we would seek help and advice from Professor Spalding. This, more often than not, tended to be a rather humbling experience as he has this amazing ability of being a great lateral thinker when it comes to resolving problems and issues. So much so, that as one left his office you would be feeling rather sheepish and somewhat irritated as invariably the solution was rather simple in the end and why could we not think of it before? However, I suppose this is what separates the genius from the rest of us mere mortals!

For another 15 years or so after leaving CHAM I was very heavily involved in using PHOENICS, firstly at GEC Alstom in Rugby and later at Connell Wagner (now Aurecon) when I made the move "Down Under" to live in Melbourne, Australia. I last saw Professor Spalding at the 2004 PHOENICS User conference in Melbourne. It was evident to me then that he was still heavily involved in all things PHOENICS and CHAM, and was still very keen on developing new innovations in the CFD arena that could have potential benefit for others and to the industry and world at large.

Unfortunately, these days with my present company at AMOG Consulting, I have been involved with CFD and PHOENICS to a much lesser extent, being involved primarily with system safety design in the marine, offshore and mining industries. However, I still appreciate and count myself lucky to be able to say that I was fortunate to have had a direct association and connection with Professor Spalding during my 10 years at CHAM and involvement in using PHOENICS for over 25 years.

I certainly feel privileged to be associated with the early development days of PHOENICS to what it has now evolved to, and over those 25 years have used PHOENICS for analyses ranging from seaweed farming in Japan, atmospheric boundary layer flows over the glacial forests in Scandinavia, blast furnaces and steel making in Bavaria, VSTOL aircraft in ground effect right through to stadium

comfort and life safety studies for the renowned MCG (Melbourne Cricket Ground) and the recently redeveloped Wembley stadium.

My only slight angst, is that now just turning 50 and “going over the hill” (or so I am told), in order to try and follow in Professor Spalding's monumental wake I have got yet another 40 plus years of working life still to go – Aarrghhhh.....!!!

Eric Jal, email: eric@thejal.net

Work with PHOENICS

CHAM, Wimbledon, London, United Kingdom

V/STOL Aerodynamics

Numerical prediction of the engine exhaust hot gas re-ingestion for the British Aerospace Harrier V/STOL aircraft hovering in close proximity to the ground. This consideration is of particular relevance to any proposed design of a supersonic version of the aircraft. In particular, the effect upon the aircraft lift was demonstrated and included the appraisal of lift augmentation devices to improve the hovering stability at low heights.

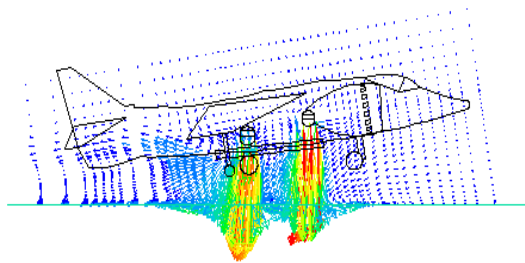

Condenser Equipment

An evaluation was performed for a condenser of an industrial power plant. In addition to assessing the pressure drop across the condenser inlet (minimising this thereby enables an increase in the power output from the low-pressure turbines), a Lagrangian assessment was conducted for the water droplets carried by the steam flow, as this was causing damage and fatigue to the tube bundles. The droplet motion predictions correlated well with the observed severe damage patterns experienced in certain parts of the tube bundles.

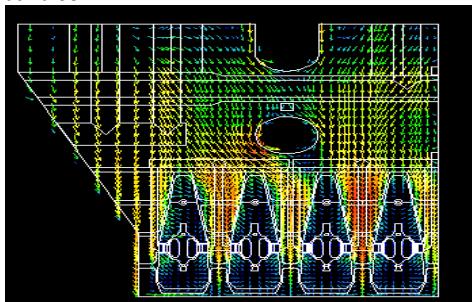

Helicopter Engine Intakes

Design evaluation of the flow around helicopter engine intakes operating in extreme environments. This included the assessment under desert conditions for the investigation of the efficiency of various proposed air intake filter designs in order to mitigate the problem of sand ingestion erosion. In addition, the prediction of potential ice build-up within the engine intakes in the cold arctic atmosphere was also examined.

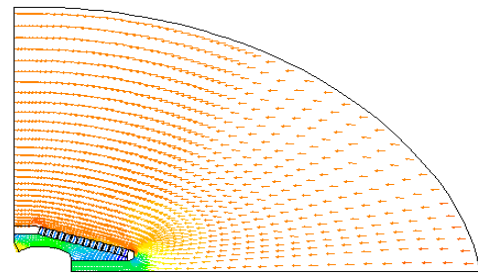

Gun Muzzle Flows

The appraisal of artillery guns firing in dusty or desert environments. Of specific concern was the extent of the formation of the dust cloud created from the gun nozzle pressure blast, which can result in uncomfortable or dangerous conditions for the operating personnel. The design study evaluated different gun muzzle shapes to mitigate the problem.

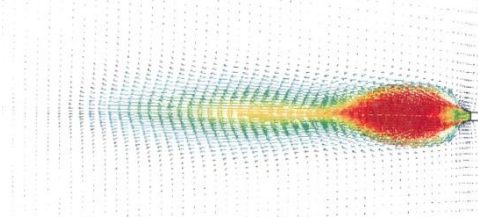

GEC Alstom, Rugby, Warwickshire, United Kingdom

Governing Valve

Due to excessive noise and vibration experienced during site operation with a particular type of steam turbine governing valve, an investigation was conducted to establish the cause of the problem. The PHOENICS analysis indicated that flow separation was occurring at the valve seat that led to a flow instability being induced causing acoustic resonance (this was also confirmed by experimental tests). The design solution proposed the inclusion of a number of vanes on the guide ring, which when fitted eliminated the problem.

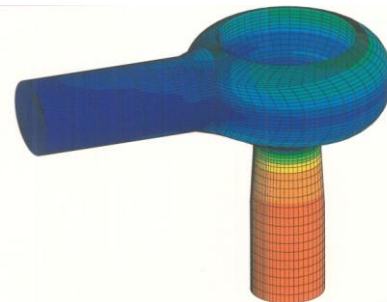

Gland Leakage

Following a proposal to reduce the number of castellated gland fins, a design assessment was performed to establish the effect this would have upon the overall diaphragm leakage. The analysis indicated that by reducing the number of fins the leakage flowrate would increase. As a result the numbers of gland fins were not reduced in the final diaphragm design.

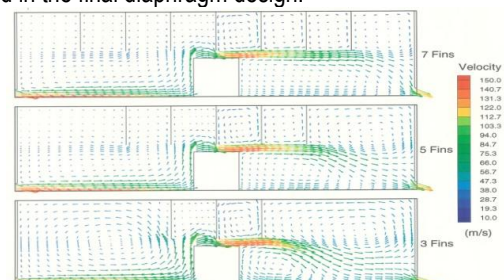

Blading Design

The three-dimensional flow within the blade passage is highly complex and 'secondary' flow losses can be significant. In order to understand these complex secondary flows, which are dominated by viscous effects, a computational assessment was conducted. In addition, data obtained from experimental cascade and air-turbine tests was used to provide validation of this numerical process. In this manner, the reliance of the numerical analysis was corroborated, thus demonstrating this method to be an invaluable tool in the blading design optimisation process.

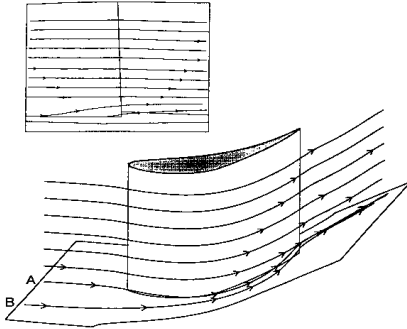

Inlet Belt Flows

Design analyses were performed for the flow behaviour in cylinder casing inlet belts. Ideally, the flow in these casings should be stable and uniform as possible prior to entry into the first stage fixed blades (nozzles). If unsteady circumferential (swirling) flow occurs then the efficiency of the turbine operation can be reduced. To alleviate any flow unsteadiness, judicious placement of flow splitter plates were investigated by PHOENICS and shown to improve the flow uniformity onto the nozzles (confirmed subsequently by lab tests).

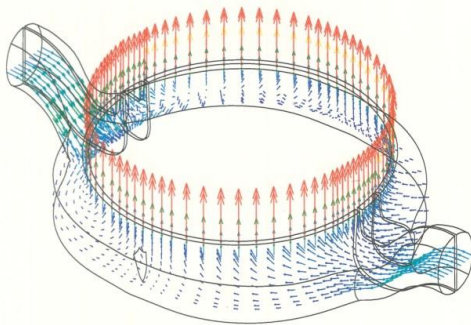

Connell Wagner, South Melbourne, Australia

Wind Flow Around Buildings

Various projects involving analysis of wind flow around buildings including assessment of wind gust conditions for pedestrian comfort and safety within CBD regions (city centres) and for exposed footbridges and walkways. It was established that using CFD modelling at an early stage of façade design allowed evaluation of designs in a more cost effective manner compared to traditional wind tunnel tests or use of building code standards which can lead to over conservative designs.

Tunnel Fires

Assessment of a number of ventilation and fire safety cases for road and rail tunnels including Mt Victoria tunnel near Wellington in New Zealand, a bi-directional two-lane vehicular tunnel, with a transverse ventilation system that had not been updated since being built in 1933. Based on PIARC design fire sizes of a typical car (5MW) and coach/lorry (20MW), PHOENICS modelling was conducted to predict smoke and temperature distributions. From the results, recommendations were provided to the client in

upgrading the smoke management system and procedures to control any fire occurrence.

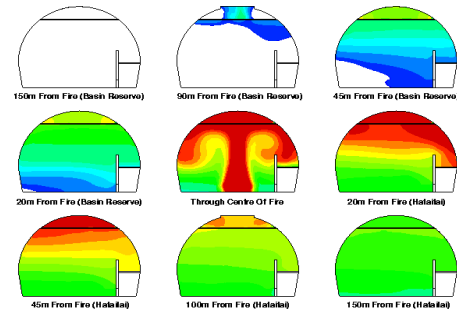

Stadia Design

Investigations for several stadia both within Australia and internationally were performed. One such example is the world renowned Melbourne Cricket Ground (MCG) which has been recently redeveloped. Ventilation is a crucial factor in the new facility and PHOENICS was used to analyse the flow within and around the stadium. One study examined the relative changes in the air movement patterns across the pitch due to the construction of the new Northern side stand.

Building HVAC Assessments

Conducted assessments of natural and HVAC analyses within buildings. One example was for a Museum upgrade; due to the building's heritage status, the refurbishment was performed under heritage constraints. Innovative solutions had to be adopted to enable the services to be concealed without compromising the level of performance, such as in the re-use of the original airshafts in the main hall for the air-conditioning system. Several non-obtrusive ventilation systems were evaluated, and a displacement system was recommended.

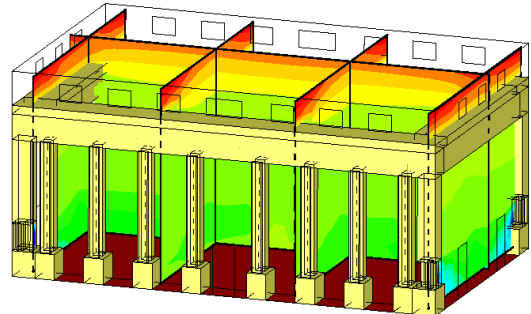

Professional Publications Using PHOENICS

1. "Numerical Prediction of Flow Entrainment Around a V/STOL Aircraft in Ground Effect". E N Jal, D R Glynn & C M Milford, Powerful Computing Systems for Fluid Flow Applications. BHRA, London, UK, June 1988.
2. "Modelling of Industrial Power Condensers and Its Application To Droplet Erosion". E N Jal & H Tinoco, Engineering Applications of CFD, IMechE, London, UK, September 1993.
3. "Use of PHOENICS for Turbomachinery Applications at GEC Alstom". E N Jal, PHOENICS User Conference, Trento, Italy, November 1995.
4. "Energy Smart Sports Stadium Design". E N Jal & M D Macdonald, Shaping The Sustainable Millennium, Brisbane, Australia, July 2000.
5. "Applying CFD to Environmental Flows". E N Jal, PHOENICS User Conference, Melbourne, Australia, May 2004.
6. "Using CFD for Sports Arena and Stadia Design". E N Jal, EcoLibrium Journal, Volume 3 No 9, AIRAH, October 2004.

2.4 Professor Spalding, CHAM & PHOENICS by Gordon Read

I have just read the Autumn 2012 CHAM Newsletter online, and, whilst a little late, I thought the following may be of interest: I graduated with a first in Mathematics, Statistics and Computing from Thames Polytechnic (now The University of Greenwich) in June 1990. At the time, there was a recession – some things never change - and it took me some six months to find work after graduating. That first place of employment was CHAM where I started in January 1991. I worked with Jeremy Wu and others on the PHOENICS code doing general debugging and testing work, occasionally with John Ludwig, Michael Malin, Simon Drake and Adam Green.

I left after about 3 years or so and have been in software development ever since. I am now a self-employed independent software consultant working on behalf of various financial institutions including Barclays Capital, The New York Stock Exchange, The London International Financial Futures and Options Exchange, Market and BlueCrest Capital Management.

I have always considered that there are certain turning points, where a decision - whether by yourself or another person - is made that can change the direction that you take in your life. One of those turning points is when someone decided that I was worth employing at CHAM 23 years ago. From this point of view, Brian Spalding gave me my first opportunity of employment for which I will always be extremely grateful.

Gordon Read email: Gordon.Read@bluecrestcapital.com

Back to the Present

3) Agents

3.1 Agent Reports

3.1.1 Comparison of Near-Field CFD & CALPUFF Modelling Results Around a Backup Diesel Generating Station Using PHOENICS

Prepared by Zivorad Radonjic¹, Dr. Vladimir Agranat², Dr. Douglas Chambers¹, Bosko Telenta¹, Bohdan Herbenyk¹ & Travis Ritchie³

¹ SENES Consultants Limited, Ontario, Canada

² Applied Computational Fluid Dynamics Analysis, Thornhill Ontario Canada

³ Yukon Energy Corporation, Whitehorse, Yukon, Canada

ABSTRACT

An air quality assessment was completed in support of a permit renewal application for a backup diesel generating station in Dawson City, Yukon. Due to the fact that the plant is situated in a valley and experiences stagnant conditions each year that can inhibit the movement of air, the CALPUFF model was considered appropriate to determine the effect of plant emissions on community air quality. However, because it was also anticipated that building downwash would be a primary factor in determining maximum predicted contaminant concentrations in close proximity to the power house, a computational fluid dynamics (CFD) modeling analysis was

also undertaken, using the PHOENICS CFD software, to verify the accuracy of near-field CALPUFF modeling results.

The diesel engines at the station are housed in a low building (<5 meters), vented through short, curved exhaust stacks such that the exhaust gas is released horizontally rather than vertically. Emissions from four diesel engines, ranging in size from 800 to 1500 kW, were modeled in CALPUFF as individual point sources for both actual operations in 2010 and 2011, as well as for a hypothetical scenario of maximum sustained operation at 100% capacity factor. Based on the highest predicted concentrations from CALPUFF modeling, meteorological conditions conducive to building downwash were identified and selected for CFD modeling.

The PHOENICS CFD modeling results indicated that the predicted concentrations due to building downwash were closely correlated with wind speed, with the highest concentrations occurring with the highest wind speeds. The PHOENICS CFD modeling results were consistent with those derived from the CALPUFF model, with CFD maximum predicted concentrations being less than 10% higher than those estimated using the CALPUFF model. However, whereas the CALPUFF model predicted the maximum point of impingement to occur at the facility property line beside the power house, the CFD model predicted the maximum concentrations to occur 10-20 meters from the property line.

The comparison of modeling results showed that the differences between the maximum predicted contaminant concentrations in close proximity to the source for building downwash effects derived using the CALPUFF model were not very different from those that would be derived from a more complex simulation of wind flow around a small building using CFD modeling techniques. The analysis provides justification for using the CALPUFF model to represent near-field contaminant concentrations in similar regulatory applications. Additional analysis would be required to verify whether the two models would continue to provide similar results for higher building heights, higher stacks or more complex building shapes.

Submitted by Dr Vladimir Agranat, ACFDA, Canada

3.2 Agent Activities

2013	Activity
January 10	Shanghai Feiyi, China: PHOENICS User Meeting, Hangshou Zhejaing Province; 70 Users attended
January 11	Shanghai Feiyi, China: Zhejaing Province Annual Architecture Meeting; paper presentation & Exhibition participation.
January 12-13	Shanghai Feiyi, China: PHOENICS Annual User Meeting, Nanjing City
January 13	Shanghai Feiyi, China: PHOENICS User Seminar, Nanjing City
January 15	Shanghai Feiyi, China: PHOENICS User Seminar and training in Guangzou
January 28	Shanghai Feiyi, China: PHOENICS User Meetin, Zhenzhen

4) CHAM / PHOENICS Activities

4.1 SimScene Focus by James Stewart, CHAM

As part of an on-going collaboration between the Politecnico di Milano and CHAM Ltd, a new special-purpose PHOENICS simulation scenario, known as a *SimScene*, is to be created, focussing on the numerical analysis of two-phase flows within slurry carrying horizontal pipe-lines. This *Slurry SimScene* is intended to form an extension of an earlier cooperative development detailed in the paper entitled: **Numerical Prediction of Pressure Gradient of Slurry Flows in Horizontal Pipes** [G. V. Messa; M. Malin and S. Malvasi].



Fig. 1: Horizontal slurry carrying pipeline system, <http://www.tenaris.com/en/Products/OnshoreLinePipe/Minera/SlurryPipelines.aspx>

The general purpose of a *SimScene* package is to provide a simple means for non-CFD experts to conduct effective CFD studies. In the specific case of the *Slurry SimScene*, the target users will be designers of pipeline systems for the conveyance of slurry flows. In this context a slurry flow is considered to be a fluid-solid mixture in which the volume fraction of the latter is sufficiently large for particle-particle interaction to exert significant influence on the flow. It is the aim of the pipeline designer to ensure that the slurry flow is moving sufficiently quick enough to eliminate the possibility of sedimentary deposition within the bottom of the pipe.

Following the published work referenced above, the *Slurry SimScene* will utilise an Eulerian two-fluid flow model combined with a modified $k-\epsilon$ turbulence model. The numerical modelling and computational details will be prescribed by the *SimScene* creator to alleviate the need for User CFD-proficiency, thus broadening the applicability of the package to a wider industrial user range.

With the numerical details taken care of in a “hidden-from-user” manner, the *Slurry SimScene* user will be presented with a simple interface, such as that seen in the previous image, through which the geometrical setup; the material properties of the two phases; the inflow and the boundary conditions for the case can be specified. Once the user has adjusted the case to satisfy their needs, the *Slurry SimScene* interface can be used to run the PHOENICS solver – EARTH to perform the CFD calculation.

When the simulation is completed, the *Slurry SimScene* will provide a range of information relating to the main features of a two-phase slurry flow, namely: the pipe pressure gradient; the solids volume fraction distribution

throughout the pipe and the velocity distribution within the pipe. The slurry pipeline designer can then use the results to determine the suitability of the pipe design and pump capacity based on these vital flow characteristics.

As a result, it is clear that the *Slurry SimScene* will provide a simple, cost-effective means of performing crucial design-stage CFD studies to aid the development of optimal slurry carrying pipeline designs.

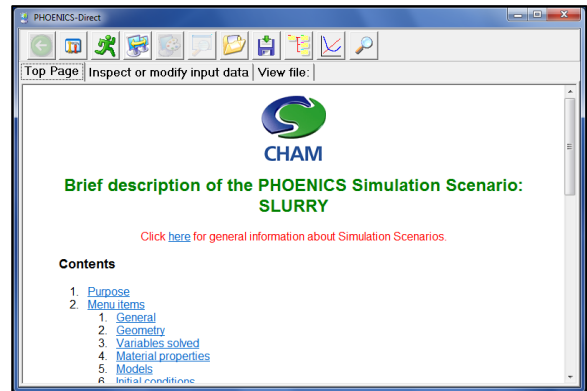

4.2 Data Cooling & Optimization Conference

CHAM personnel will be present at the IMechE Conference & Exhibition on June 6 2013, entitled **Data Centre Cooling and Optimisation - working with the environment – 2013**

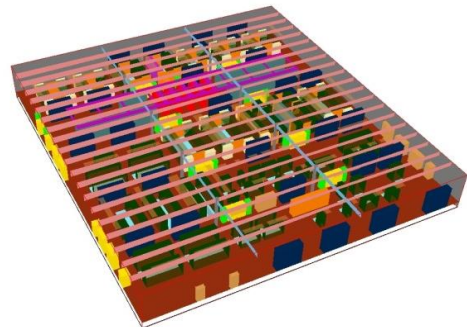

A range of data centre simulation cases will be on display, employing the latest features and techniques for rapid data centre performance simulation, including failure scenarios and system optimisation.

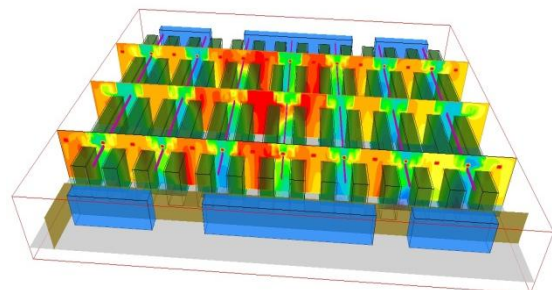

Venue: Institution of Mechanical Engineers. 1 Birdcage Walk, Westminster, London SW1H 9JJ, <http://www.imeche.org>

5) PHOENICS Applications

5.1 PHOENICS modelling of 3-D flow over a surf reef and comparison with experiment by R Hornby

Introduction

In an earlier article (Newsletter Summer 2011), exploratory work was carried out using the PHOENICS Scalar Equation Method (SEM) to model flow over surf reefs. These simulations were 2-D transient and although favourable comparisons with other numerical methods were provided, no experimental validation was included. Experimental results are, however, available from a series of laboratory measurements conducted in 2004 (ref 1) and 2007 (ref 2) in the wave basin of the Civil Engineering Department at the Delft University of Technology. These results allow validation of the PHOENICS modelling in 3-D for realistic reef geometries.

Experimental set up

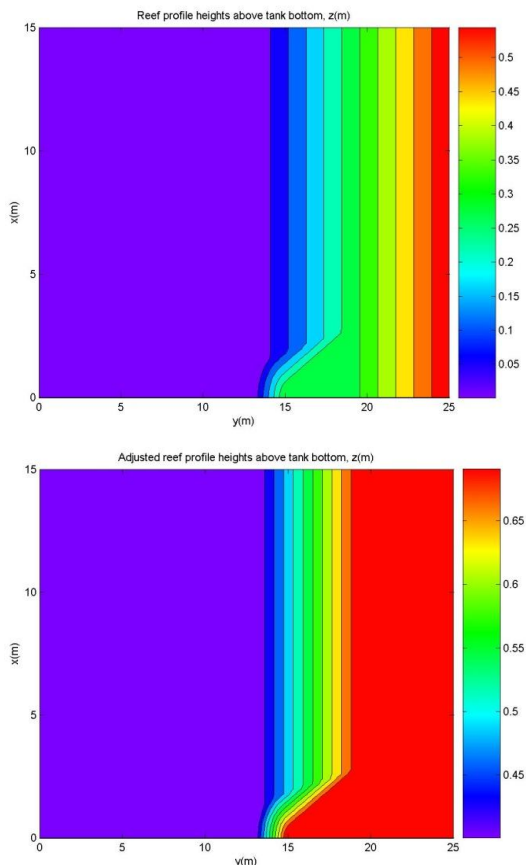

Figure 1. Top: bottom profile contours as measured in the experimental tank. Bottom: adjusted bottom profile for numerical simulation (see PHOENICS modelling text for explanation of changes). The reef structure (bottom centre in each figure) is superimposed on the uniform slope.

The experimental tank is approximately 25m long and 15m wide and contains water to a maximum depth of 0.4m. A 1 in 20 slope commences from about half way along the tank (see figure 1 top) and contains half the reef geometry superimposed on the slope with the tank wall acting as a symmetry plane. Three piston type wave generators spanning the complete width of the tank were used to produce monochromatic and bichromatic plane wave

fields which emerge from the left hand side of the tank shown in figure 1. The smooth bottom of the wave tank ensured minimal frictional dissipation for waves generated. Overall conditions in the tank provided a 1 to 12.5 scaling for a real situation, ie a surf reef in a 5m water depth.

PHOENICS modelling

The wave tank was modelled using a Cartesian grid with 45 cells in the x direction across the tank, 190 cells in the y direction along the tank and 80 cells in the z (vertical) direction. Higher cell concentrations were deployed over the reef and across the water/air interface. The slope and reef geometry were represented by fully blocked fluid cells. The vertical domain was split into two, the first 0.4m representing water and the upper 0.4m representing air. All bounding surfaces were assumed to be frictionless and the fluid flow was assumed to be laminar. The bichromatic wavefield described in the experiment (primary wave with an approximate period of 2s, wavelength of 4m and peak to trough amplitude of 0.06m) was obtained by use of sinusoidally varying mass and momentum sources on the south face of the tank domain. The PHOENICS SEM was used to model the water and air flows with 200 time steps per period for the wave flow over the reef section.

Initially the bottom profile geometry shown on the left of figure 1 was used but this resulted in divergence as soon as waves started to break downstream of the reef on the 'beach' section of the slope (note that in the experiment the large y section of the slope was not covered by water since it rose above 0.4m). This divergence could be cured by careful adjustment of the cell density and time step (at significant computational cost) but since this 'beach' breaking phenomenon is irrelevant to the wave flow over the reef, it was decided to adjust the bottom profile downstream of the reef to a maximum height of 0.32m (figure 1, right). This ensured a minimum water depth of 0.08m. In addition, to avoid wave reflection from the north tank face, vertical velocities downstream of the reef were damped using a resistance term in the z momentum equation proportional to the vertical velocity.

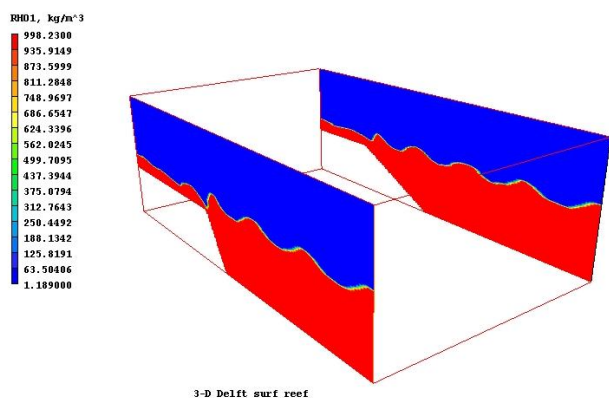
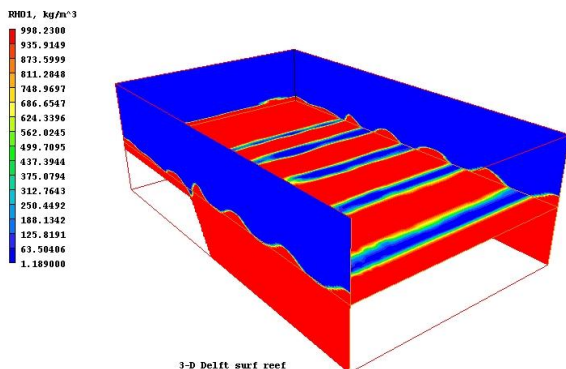

Figure 2. PHOENICS results looking down the wave tank after 36 wave periods have elapsed (water is coloured red and air blue). Note the vertical scale is magnified by a factor of 10 for clarity.

Figures 2 and 3 show the results achieved after 36 wave periods. The enhancement of wave height over the reef is

clearly visible (and to a lesser extent over the slope) as is the effect of the velocity damping in smoothing out the waves downstream of the reef. The reduction in wave velocity over the reef is also apparent.

Figure 3. PHOENICS results looking down the wave tank after 36 wave periods have elapsed (water is coloured red and air blue). Note the



vertical scale is magnified by a factor of 10 for clarity.

Comparison of results with experiment

Extensive experimental results are available but for brevity the Root Mean Square (RMS) wave heights along the peak section of the reef ($x=0.5m$) and base of the reef ($x=2.5m$) are chosen for comparison with the PHOENICS results from the last 24 wave periods (the first 12 wave periods are used to generate a statistically 'steady' wavefield). The results are shown in figure 4 and show an encouraging agreement.

Conclusions

The PHOENICS SEM has been shown to give good agreement with experimental results for the RMS wave height over a surfing reef. The SEM requires careful attention to be paid to the distribution of spatial cells in order to capture the required detail in the flow and smaller time steps need to be used as waves steepen over the reef if divergence is to be avoided.

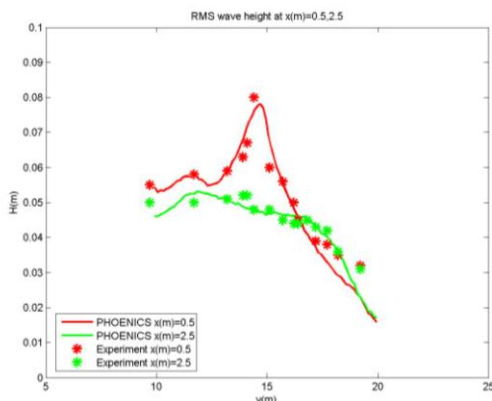

Figure 4. Comparison of PHOENICS and experimental results for the RMS peak to trough wave height along the tank at $x=0.5m$ (reef peak) and $x=2.5m$ (reef base).

References

- Henriquez M, 2004. Artificial Surf Reefs MSc Thesis Dept of Civil Engineering Delft University of Technology, Delft.
- Poort M C L, 2007. Rip currents MSc Thesis Dept of Civil Engineering Delft University of Technology, Delft.

Dr R. P. Hornby e-mail: bob@hornby007.wanadoo.co.uk

6) PHOENICS 2012 Update by John Ludwig of CHAM

Herewith some of the features to PHOENICS 2012 and updated in December 2012:

Pre-processor (VR-Editor)

- Inlet objects have a vector arrow showing the direction of flow.
- Main Menu allows setting of domain edge boundary conditions.
- Activation of transient restarts made easier.
- Object names can be up to 12 characters long.
- Q1 can be saved to a different name without saving all the output files 'File – Save Q1 As...'
- The dialog for starting parallel has been updated to allow more flexibility.
- Facilities for repairing and manipulating CAD data during and after import have been improved through the new DatMaker utility.
- DatMaker can be used to perform operations on objects already created in VR. Existing objects can be merged, split or subtracted. (1) Here there are 5 air blockages making a channel through a hidden solid; (2) then merged into one object; and (3) now subtracted from the solid leaving a channel.

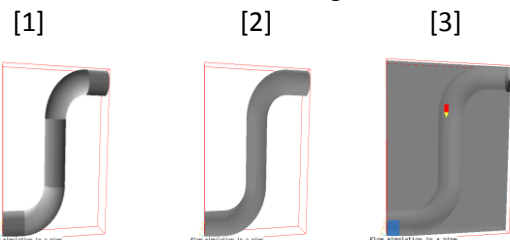

Post-Processor (VR-Viewer)

- Start-up dialog offers most recent set of results.
- New function key F9 always loads most recent set of results.
- The domain can be mirrored in any direction.
- Vectors can be drawn as 3D arrows.
- Contours and vectors can be plotted on an arbitrary surface of any shape – the 'Plotting Surface' object.

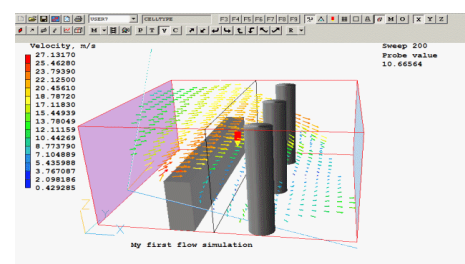
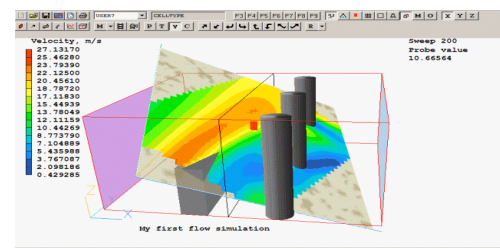

- Contours have new Fill and Line options

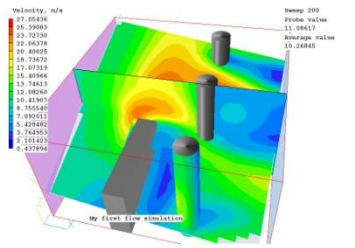

Fill

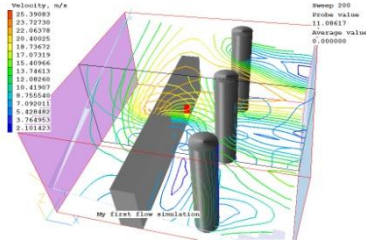

Lines

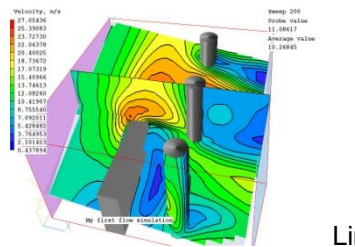

Lines & Fill

- Objects have a 'Selectability' flag.

PHOENICS Solver - EARTH improvements

- A full double-precision version of the Earth solver is available.
- The normalised residuals displayed on the monitor screen have been updated to improve convergence monitoring.
- The wall function coding has been updated.
- New IN-FORM commands available.
- Calculation of the average outlet temperature for printing in RESULT made more accurate and robust.
- In parallel PHOENICS, the 'pbc-bound cells' error has been removed.
- The working directory status is echoed to the title bar of the EARTH solver window and to the RESULT file.

SUNLIGHT OBJECT Update

The 2010 SUNLIGHT feature has been upgraded. The main improvements made are:

- No longer accessed through WIND, there is a separate SUN object.
- The required inputs can be read from a standard EPW Weather Data File.
- A link to the EPW site is provided for easy download of weather data files.
- The WIND object can take the wind speed and direction from the same weather file. The pre-attached data file is used and current data are shown.

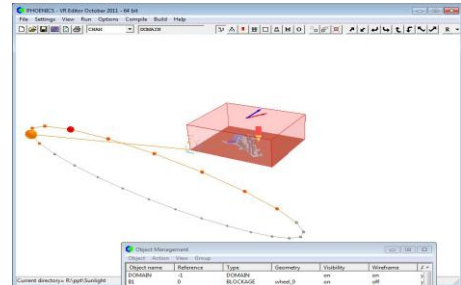
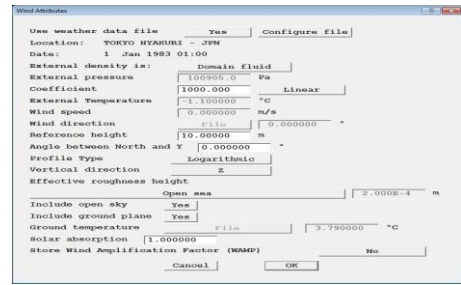

- Transient operation improved.
- The amount of incident solar radiation absorbed by each object in the scene can be set by the user.
- In a transient case, the time-step setting dialog controls the time step size and number of steps to run.
- When a SUN object is active, the 'Solar absorption' factor of the WIND ground plane can also be set.
- The 'Wind Amplification Factor' (local absolute velocity divided by reference velocity) can be STORED.

Previous highlights

Some improvements made in the previous release are worth mentioning again, in case they have been missed.

- The 'Object affects grid' attribute has been split into the three coordinate directions.
- A long-standing error in the Auto-mesher has been corrected.
- In PHOENICS/FLAIR, the 'Calculate link temperature' and 'Activation temperature' settings for a SPRAY_HEAD object activate the spray automatically when the activation temperature is reached. A table file containing the calculated link temperatures at the end of each step is also produced.
- The ambient settings represent the pressure and temperature outside the domain and become the default values at all inlets and openings.
- ANGLED-IN objects can now link the flow rate and temperature at one boundary condition to the flow and temperature at another.

To contribute an article to the PHOENICS Newsletter please email to cik@cham.co.uk. Thank you.



**Concentration Heat & Momentum (CHAM) Limited
Bakery House, 40 High Street, London SW19 5AU, England**